

Submittal Package

viiega

Viega PEX Crimp Zero Lead Eco Brass Fittings

Technical Data

Materials:

Fittings.....	Eco Brass®
Crimp Rings.....	Copper (black)
MANABLOC® Manifolds.....	Polysulfone (plastic) with Eco Brass or PolyAlloy™ fittings
PEX Crimp Copper Manifolds.....	Copper with Eco Brass alloy fittings
PEX Crimp Poly Manifolds.....	PolyAlloy crimp connections
Valves.....	Eco Brass and PolyAlloy
ViegaPEX™, ViegaPEX Ultra Tubing.....	PEX (crosslinked polyethylene)

Applications

PEX zero lead brass and Polyalloy PEX Crimp fittings are intended for use in potable water systems. They can be directly buried in soil but shall be wrapped (fittings used in concrete shall also be wrapped). Fittings are manufactured with PEX Crimp barbs for use with ViegaPEX, ViegaPEX Ultra tubing, crimp rings and tools.

Installation

- Use only ASTM F1807 crimp rings and approved full circle crimp tools to make connections.
- Keep flame and excessive heat away from tubing and connections.
- Refer to the PEX Water Systems Installation Manual for additional information.

“Zero Lead” identifies Viega® products meeting the lead free requirements of NSF 61-G through testing under NSF/ANSI 372 (0.25% or less maximum weighted average lead content).

Codes Approvals & Standards

ANSI/NSF 61-G

cNSF® us pw-G

CSA B137.5

U.P. Code

UPC®

ASTM F876 / F877

ASTM F1807 / F2159

ICC ES-PMG™ 1038

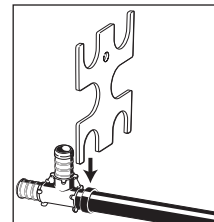
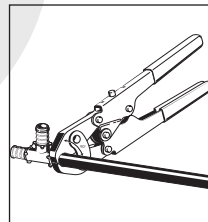
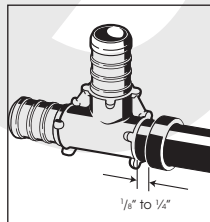

THREE SIMPLE STEPS TO A SECURE PEX CRIMP FITTING CONNECTION.

1. SLIDE CRIMP RING OVER END OF SQUARED OFF TUBING, FULLY INSERT FITTING INTO TUBING AND POSITION THE RING 1/8" TO 1/4" FROM THE END OF TUBING.
2. KEEP THE TOOL AT 90° AND CLOSE THE HANDLES COMPLETELY. DO NOT CRIMP TWICE.
3. CHECK CRIMP WITH GO/NO GO GAUGE.

Submittal Package



Viega PEX Crimp Zero Lead Eco Brass Fittings

ViegaPEX and ViegaPEX UltraTubing

Material.....PEX crosslinked polyethylene
Temperature/Pressure Ratings...200°F at 80 psi
180°F at 100 psi
73.4°F at 160 psi
Linear Expansion Rate.....1.1"/100'/10°F

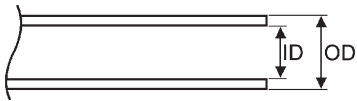

Nominal Size	Inner Diameter	Outer Diameter	Wall Thickness
3/8"	0.35	0.500±.003	0.070±.010
1/2"	0.47	0.625±.004	0.070±.010
3/4"	0.67	0.875±.004	0.097±.010
1"	0.86	1.125±.005	0.125±.013

Submittal Package

viega



Viega PEX Crimp Lav 90° Elbow Zero Lead Copper Crimp x Lav - Model V5076

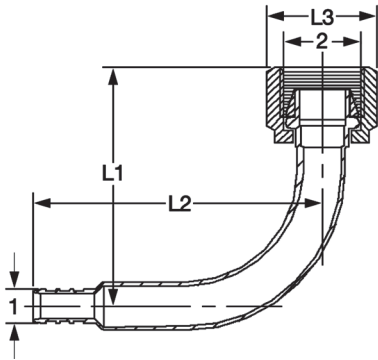

Part Number	Size		L1 (in)	L2 (in)	L3 (in)
	1	2			
44201	3/8" x 1/2" Lav (plastic nut)		2.25	2.73	1.12

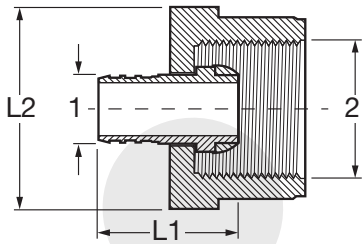

Viega PEX Crimp Closet Adapter Zero Lead Brass Crimp x Closet - Model V5072ZL

Part Number	Size		L1 (in)	L2 (in)
	1	2		
46223	3/8" x 1/2" Closet (plastic nut)		1.36	1.16
46234	1/2" x 1/2" Closet (plastic nut)		1.36	1.16

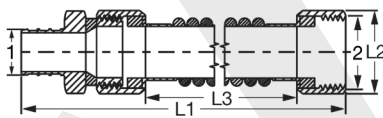

Viega PEX Crimp Swivel Connector Zero Lead Copper For Water Heater Crimp x FPT - Model V5048ZL

Part Number	Size		L1 (in)	L2 (in)	L3 (in)
	1	2			
46764	3/4" x 3/4" F NPT		19.00	1.13	18.00